

# BOLT RANGE

Concrete Top Wash Basins  
(DOUBLE, TO SIDE, CENTRED, TAP HOLE INCLUDED)

**HARD** BY  
DESIGN

## SINGLE LEFT

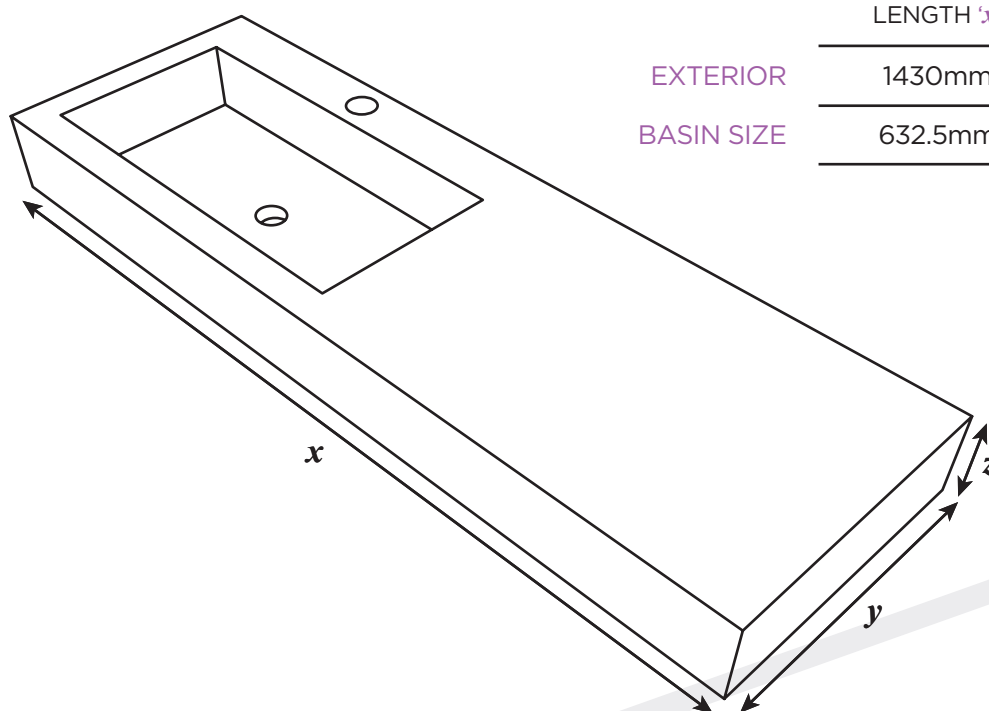

### SPECIFICATION

	LENGTH 'x'	WIDTH 'y'	HEIGHT 'z'
EXTERIOR	1430mm	460mm	130mm
BASIN SIZE	632.5mm	305mm	110mm

WEIGHT 42.5Kg

### BOLT

"BOLT" our double wash basin range with tap hole is finished to the highest of standards and are all sealed with our standard sealer.

As with every natural product, concrete will react to its environment and patina as it ages. Products are not under warranty against staining. Cleaning regularly will protect

We recommend using non-abrasive cleaners such as Method All-Purpose Natural Surface Cleaner with a sponge or towel.

Further information on this can be found in the Care and Maintenance PDF which can be downloaded separately.

### COLOUR

As with all our products at Hard by design, we can offer you this product in 7 of our unique colours.

These colours have been created by hand using different variations of colour pigment to achieve a variety of appealing colours. From natural and subtle to colourful and visually striking.

Our 7 colours can be chosen from our colour swatch pdf located on page 2 of this document.

### FINISHES

We also can provide for you the customer a range of different finishes to tailor for your needs.

Currently we offer 5 different finishes including; Smooth, Natural, Sandblast, Board form and Textured.

You can view a sample of each of these textures on page 2 of this document.

# COLOURS & TEXTURES

**HARD** BY  
DESIGN

## Standard COLOUR Range

Our 'Standard' range of colours comprises 7 popular colours which are shown below.

We have an additional range of bespoke colours available, another 17 colours which are available for download in the colours and textures section on our website. Please note that whilst the swatches below are representative of the colours, each colour has an individual quality and finish. Please ask for more details.

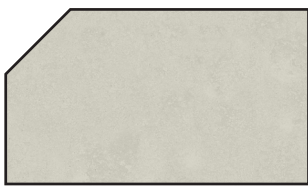

Alabaster



Coin

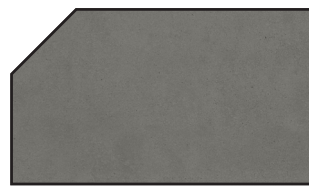

Fog



Onyx

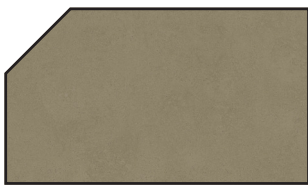

Saddle

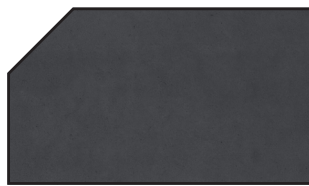

Skyscraper

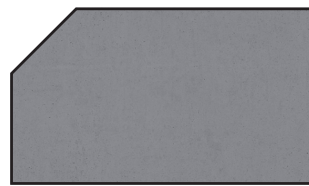

Steel

## Standard TEXTURE Range

Our 'Standard' range of textures comprises 5 popular finishes which are shown below. Please note that whilst the swatches below are representative of the textures, each texture has an individual quality and finish. We can also create bespoke textures based on your requirements. Please ask for more details.



Smooth



Natural

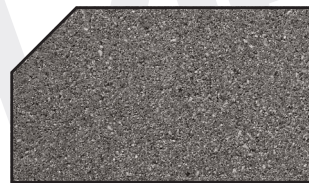

Sandblasted

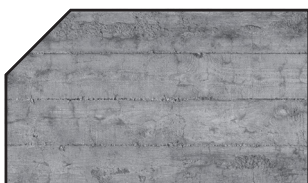

Boardform

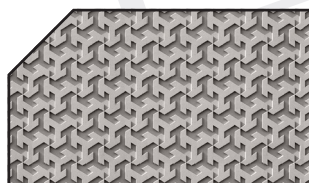

Textured